

Article number: 20474B8B8MT

Description: E+G Two-way clamp mounting - GN 474-B8-B8-MT

## Measures

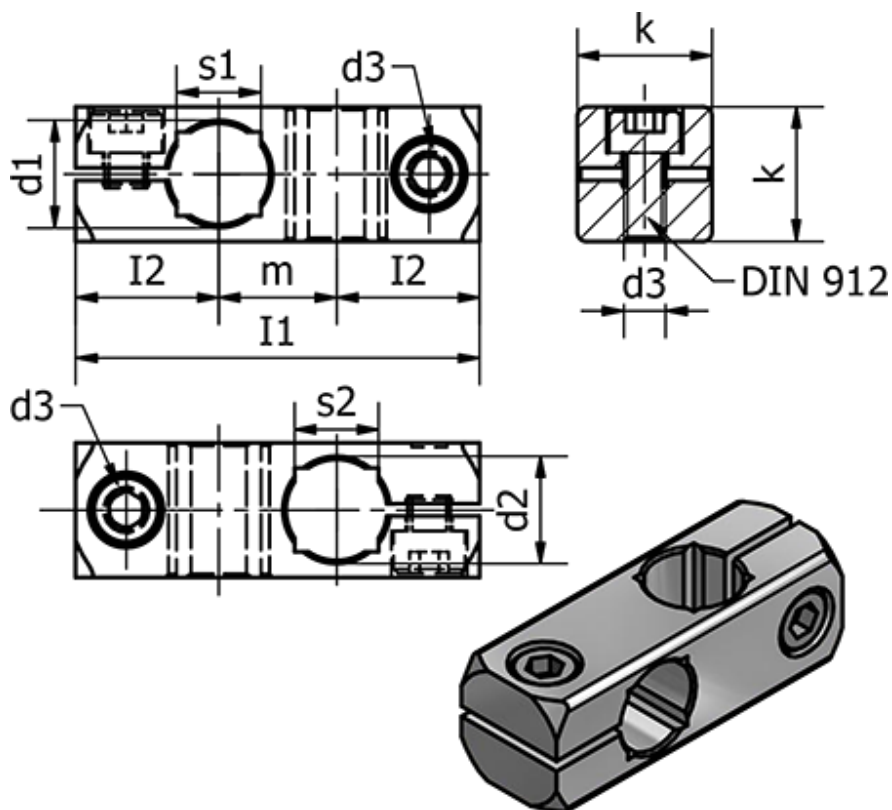

Clamping kit for d3 = GN 511-M4-14

d1 h11 = 8

d2 h11 = 8

d3 = 4

I1 = 37

I2 = 13.5

k = 14

m = 10

s1 = -

s2 = -

Weight (g) = 16